



MODEL 7012
4-12 in³ VARIABLE
DELIVERY
HELM PUMP

This pump features adjustable volume in a compact design. Adjustment from 4-12 in³ per turn is easily accomplished from the outside. A ball bearing and two thrust bearings provide smooth operation and long life. A lock valve installed on the back of the helm pump prevents rudder feedback and also allows installation of multiple control stations. The pump is normally supplied in its die cast bronze finish. It can, however, be ordered in a black epoxy finish.

Materials: Housing and rotor are die-cast silicon bronze. Pistons and pintol are hardened and ground steel. Pump shaft and hardware are stainless steel.

M.W.P: 1000 psi (69 bar)

Weight: 38 lbs. (17.2 kg)

ORDERING INFORMATION

- A – With cast bronze finish (standard)
- B – With black epoxy finish
- L – With long shaft (for behind console mount)
- N – With short shaft (for through console mount)
- P – With porting block only (no lock valve)
- V – With vent plug

Note: An adaptor plate to simplify installation of the helm pump is available. It can be installed on either side of the console.

Ordering number:

7012-0011A (cast bronze finish)

7012-0011B (black epoxy finish)

Through console installation with short shaft

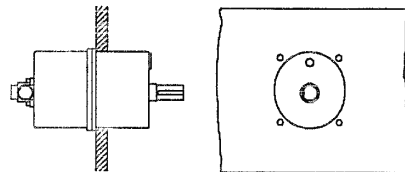

Behind console installation with long shaft

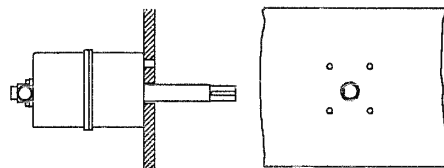

Installation with adaptor plate

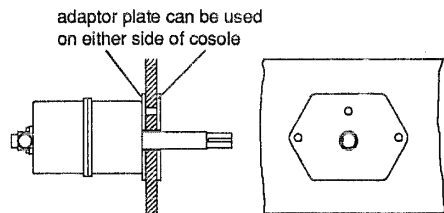

DIMENSIONS AND PARTS

MODEL 7012

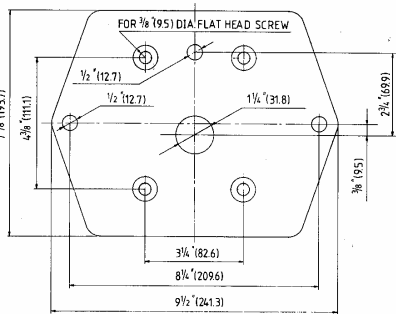
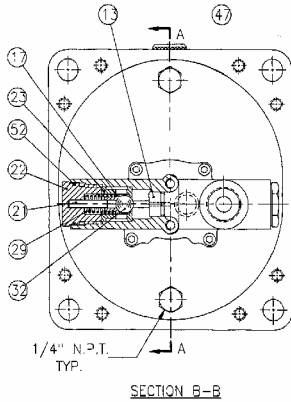
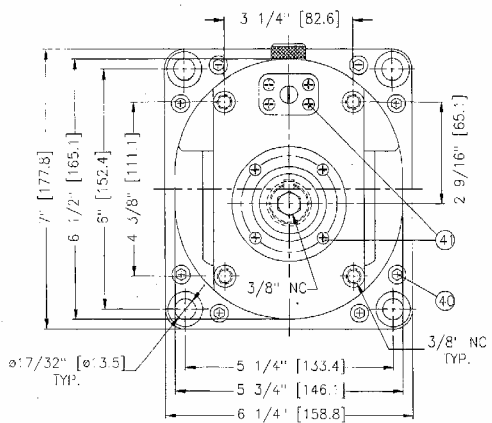
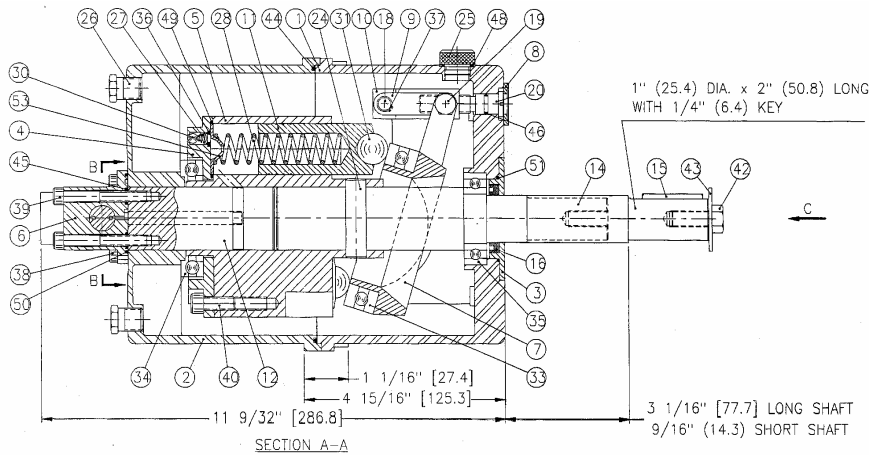

All Dimensions in inches (mm)

ITEM	QTY	PART NUMBER	DESCRIPTION
1	1	7012-0001	Front Housing
2	1	7012-0002	Rear Housing
3	1	7012-0003	Front Seal retainer
4	1	7012-0004	Check Valve Housing
5	1	7012-0005	Rotor
6	1	7012-0006	Lock Valve Body
7	1	7012-0007	Thrust Bearing
8	1	7012-0008	Adjustment cover
9	2	7012-0009	Link
10	1	7012-0010	Adjusting Block
11	7	7012-0012	Piston
12	1	7012-0013	Pintol
13	1	7012-0014	Shuttle
14	1*	7012-0015	Straight Shaft (short)
14	1*	7012-0016	Straight Shaft (long)
15	1*	7005-0019	Key
16	1	7005-11130	Front Seal
17	2	7012-0031	Spring Seat
18	1	7012-0021	Snap Ring Pin
19	2	7012-0022	Shoulder Bolt
20	1	7012-0023	Adjusting Screw
21	2	7012-0024	Pin
22	2	7012-0025	End cap
23	2	7012-0026	Ball Seat
24	1	7012-0027	Pin
25	1*	7005-0028	Filler Plug
25	1*	7005-0029	Vented Filler Plug
25	1*	7005-0030	Filler Plug with Pipe
26	2	7005-121B	Hex Plug
27	7	1201-0163	Spring
28	7	1201-0168	Spring
29	2	1201-0167	Spring
30	7	1301-0108	Ball
31	7	1301-0124	Ball
32	2	1301-0116	Ball
33	1	7012-51115	Thrust Bearing
34	1	7012-51110	Thrust Bearing
35	1	7005-6006	Ball Bearing
36	7	1029-6037	Self Locking
37	2	1029-1031	Snap Ring
38	4	1002-0810	Socket Hd Cap Screw
39	2	1002-1032	Socket Hd Cap Screw
40	15	1002-1112	Socket Hd Cap Screw
41	8	1009-0808	Flat Hd. Screw
42	1	1001-1216	Hex Hd Screw
43	1	1023-0245	Washer
44	1	1101-0163	O-ring
45	2	1101-0010	O-ring
46	1	1101-0012	O-ring
47	2	1101-0014	O-ring
48	1	1101-0017	O-ring
49	7	1101-0026	O-ring
50	1	1101-0031	O-ring
51	1	1101-0032	O-ring
52	2	1101-0021	O-ring
53	7	7012-0032	Spring Seat
(Not Shown)		7012-0011	Adaptor Plate

* Quantity may vary